

36" Electric Cooktop

800 Series - Black with Stainless Steel Frame NET8668SUC



NET8668SUC

Black with Stainless Steel Frame

Also available in:
Frameless NET8668UC

The 800 Series electric cooktop is sleek in design, and features SpeedBoost® which adds even more power to speed up the cooking process.

Features & Benefits

Bridge element accommodates oblong pans and many diameters of cookware.

Each zone's timer automatically shuts off when cooking is done.

SpeedBoost® offers shorter heat-up times for liquids.

PreciseSelect® offers 17 different direct cooking level settings.

Element Performance

Power of Front Left heating element	1,800 W
Power of Back Left heating element	1,800 W
Power of Center heating element	3,600 / 1,400 W
Power of Back Right heating element	1,200 W
Power of Front Right heating element	1,900 / 800 W

Element Size

Dimension of Front Left heating element	7"
Dimension of Back Left heating element	7"
Dimension of Center heating element	9", 6"
Dimension of Back Right heating element	6"
Dimension of Front Right heating element	8", 5"

Technical Details

Watts	10,200 W
Circuit breaker	50 A
Volts	208-240 V
Frequency	60 Hz
Plug type	No plug
Energy source	Electric



Dimensions & Weight

Overall appliance dimensions (HxWxD)	1/4" +4" x 37" x 21 1/4"
Required cutout size (HxWxD)	4" x 34 7/8" x 20"
Minimum distance from counter front	2 1/4"
Minimum distance from rear wall	2"
Net weight	37 lbs

Accessories—Optional



HEZ390210
8" AutoChef® pan



HEZ390220
9" AutoChef® pan



HEZ390230
10" AutoChef® pan

For help and assistance with Bosch accessories please visit: www.bosch-eshop.com/eshop/bosch/us or call 1-800-944-2904 Mon-Fri 5am to 6pm PST Sat 6am to 3pm PST

Notes: All height, width and depth dimensions are shown in inches. BSH reserves the absolute and unrestricted right to change product materials and specifications, at any time, without notice. Consult the product's installation instructions for final dimensional data and other details prior to making cutout. Applicable product warranty can be found in accompanying product literature or you may contact your account manager for further details.

Warranties: Bosch warrants that the Product is free from defects in materials and workmanship for a period of three hundred and sixty-five (365) days from the date of purchase. The foregoing timeline begins to run upon the date of purchase, and shall not be stalled, tolled, extended, or suspended, for any reason whatsoever. This Product is also warranted to be free from cosmetic defects in material and workmanship (such as scratches of stainless steel, paint/porcelain blemishes, chip, dents, or other damage) to the finish of the Product, for a period of thirty (30) days from the date of purchase or closing date for new construction. This cosmetic warranty excludes slight color variations due to inherent differences in painted and porcelain parts, as well as differences caused by kitchen lighting, product location, or other similar factors. This cosmetic warranty specifically excludes any display, floor, "As Is", or "B" stock appliances.

For more information on our entire line of products, go to www.bosch-home.com/us or call 1-800-944-2904

© BSH Home Appliances Corporation. All rights reserved. Bosch is a registered trademark of Robert Bosch GmbH.

05/16

36" Electric Cooktop

800 Series - Black with Stainless Steel Frame NET8668SUC



Installation Details

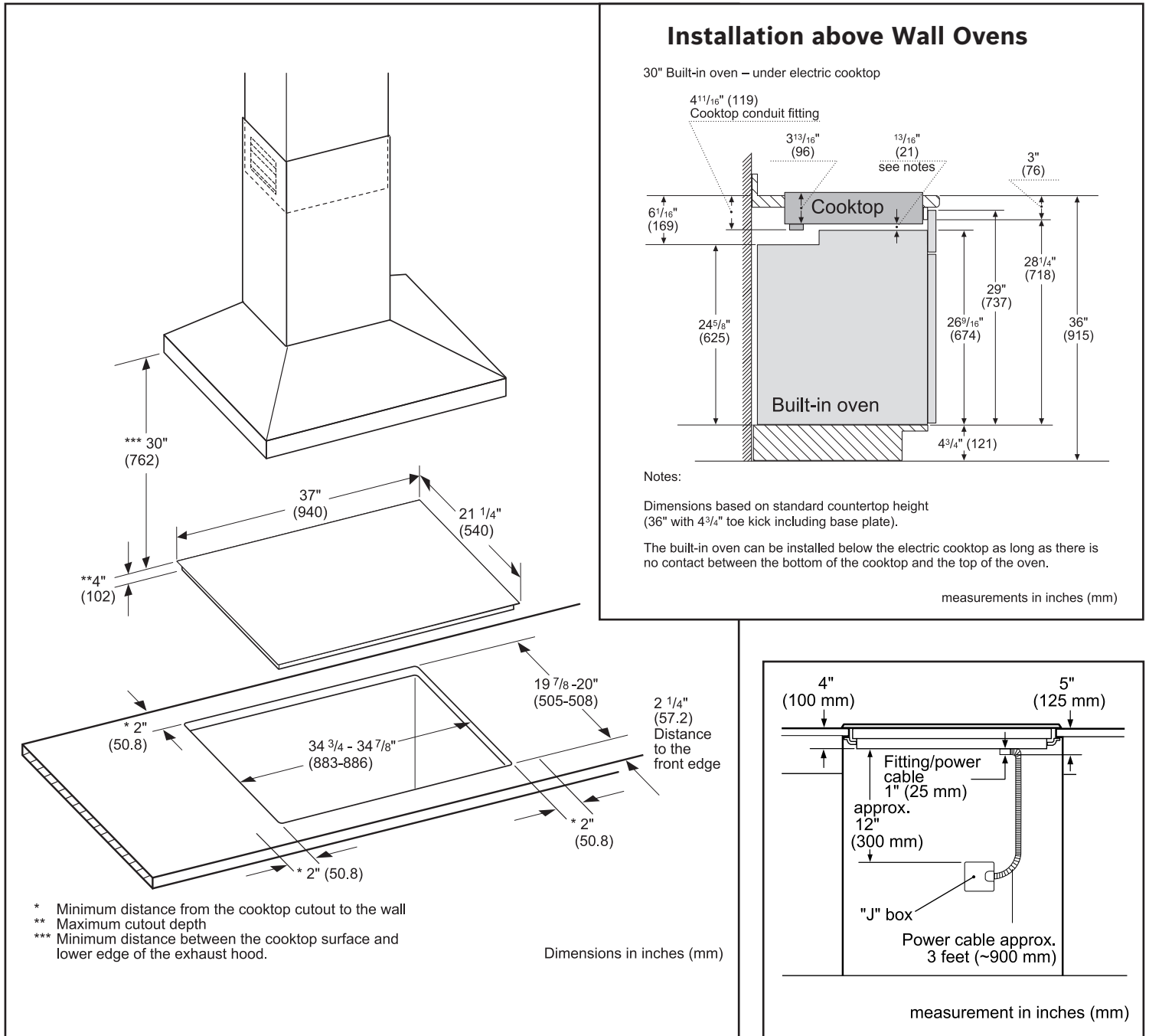

For help and assistance with Bosch accessories please visit: www.bosch-eshop.com/eshop/bosch/us or call 1-800-944-2904 Mon-Fri 5am to 6pm PST Sat 6am to 3pm PST

Notes: All height, width and depth dimensions are shown in inches. BSH reserves the absolute and unrestricted right to change product materials and specifications, at any time, without notice. Consult the product's installation instructions for final dimensional data and other details prior to making cutout. Applicable product warranty can be found in accompanying product literature or you may contact your account manager for further details.

Warranties: Bosch warrants that the Product is free from defects in materials and workmanship for a period of three hundred and sixty-five (365) days from the date of purchase. The foregoing timeline begins to run upon the date of purchase, and shall not be stalled, tolled, extended, or suspended, for any reason whatsoever. This Product is also warranted to be free from cosmetic defects in material and workmanship (such as scratches of stainless steel, paint/porcelain blemishes, chip, dents, or other damage) to the finish of the Product, for a period of thirty (30) days from the date of purchase or closing date for new construction. This cosmetic warranty excludes slight color variations due to inherent differences in painted and porcelain parts, as well as differences caused by kitchen lighting, product location, or other similar factors. This cosmetic warranty specifically excludes any display, floor, "As Is", or "B" stock appliances.

For more information on our entire line of products, go to www.bosch-home.com/us or call 1-800-944-2904

© BSH Home Appliances Corporation. All rights reserved. Bosch is a registered trademark of Robert Bosch GmbH.

05/16