

Café™ 21.3 Cu. Ft. Smart Built-In Bottom-Freezer Refrigerator

CDB36RP2RS1

CAFÉ

DISTINCT BY DESIGN™



CDB36RP2RS1
Stainless Steel with Brushed
Stainless handles



WARRANTY

Labor Warranty	Limited 1-year entire appliance
	Limited 5-year sealed refrigerating system
Parts Warranty	Limited 1-year entire appliance
	Limited 5-year sealed refrigerating system

FEATURES & BENEFITS

Exterior style	Built-in
Total Capacity	21.3 Cu. Ft.
FF Capacity	14.95 Cu. Ft.
FZ Capacity	6.32 Cu. Ft.
ADA Compliant	No
Energy Star	No
Depth	Built-In
Ice & Water Dispenser	No
Icemaker	Yes
Water Filtration	Yes
Control Type	Upfront Electronic Digital Temperature Display
Internal Lighting	LED
Colors Available	Stainless Steel
Case Color	Unfinished Sides or Panel Required
Claims & Certifications	MADE IN AMERICA, California Prop 65
Configuration	Full door
Temperature management features	Multi-shelf air management tower; independent temperature controls
Cabinet shelves (total ff & fz)	5
Door bins (total ff & fz)	6
Fresh food cabinet shelves - total	5
Fresh food cabinet shelf features	4 Adjustable glass; 1 fixed
Spillproof glass shelves	Yes
Fresh food cabinet pans/drawers	4
Clear bins and pans	Yes
Snack / deli drawer	2 Snack drawers with full extension slides
Snack / deli drawer features	Sealed
Vegetable / fruit crisper(s) / produce pans	2 Veg drawers with full extension slides
Produce drawer features	Sealed adj. humidity
Fresh food door bins	6
Fresh food door bins type	4 Adjustable/ 2 gallon size fixed position
Freezer features	Freezer drawer with wire basket on full extension slides
Freezer cabinet shelves	1 Freezer drawer/ice bucket on full extension slides
Independent utility basket	With full extension slides
Wire baskets	2
Filter change indicator	Yes - on upfront control
GE water filtration system	MWF - mounted in overhead machine compartment
Leveling system	4 Point (2 adjustable back rollers, 2 adjustable front legs)
Refrigerant type	134A
Sealed system design w/single compressor	Yes
Defrost type	Automatic defrost
Connected	ConnectPlus WiFi; App details; Display/change temperature; Alert if fresh food temperature is too high; Alert if freezer temperature is too high; Alert if water filter needs to be replaced; Alert for software OTA updates

WEIGHTS & DIMENSIONS

Overall depth	28-1/2 in.
Overall width	36 in.
Overall height	84 in.
Case depth without door	23-5/8 in.
Depth without handle	25-5/16 in.
Height to top of case	83-1/2 in.
Approximate shipping weight	640 lb.
Net weight	610 lb.

Café™ 21.3 Cu. Ft. Smart Built-In Bottom-Freezer Refrigerator

CDB36RP2RS1

CAFÉ

DISTINCT BY DESIGN™

DIMENSIONS AND INSTALLATION

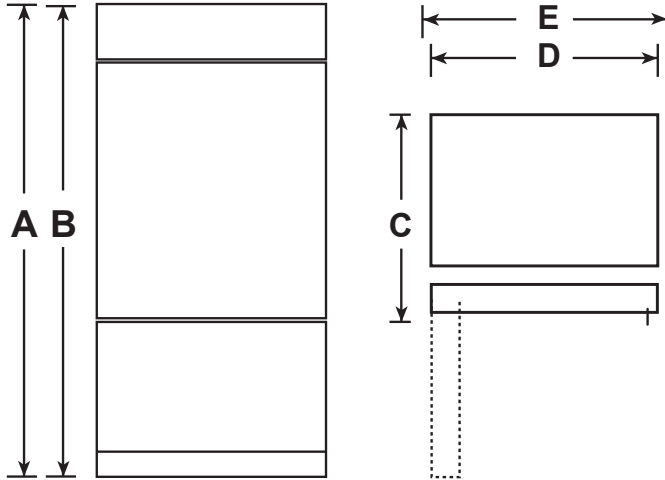

Overall Weights & Dimensions	Weights & Dimensions	
	A - Overall Height to top of grill (in)	84
B - Height to Top of Case (in)	83.5	
C - Unit Depth With Door Closed With handle (in)	28.5	
D - Case Width (in)	35	
E - Overall Width (in)	36	
Approximate Shipping Weight (lb)	640	
Net Weight (lb)	610	

Power / Ratings

Volts/Hertz/Amps 115V 60Hz 20A

**PRODUCT CLEARANCES

These refrigerators are equipped with a 3-position door stop. The factory set 115° door swing can be adjusted to 90° if clearance to adjacent cabinets or walls is restricted.

Allow full 130° door swings for pan removal. If the 90° door stop position is used, pan access is maintained, but pan removal is restricted.

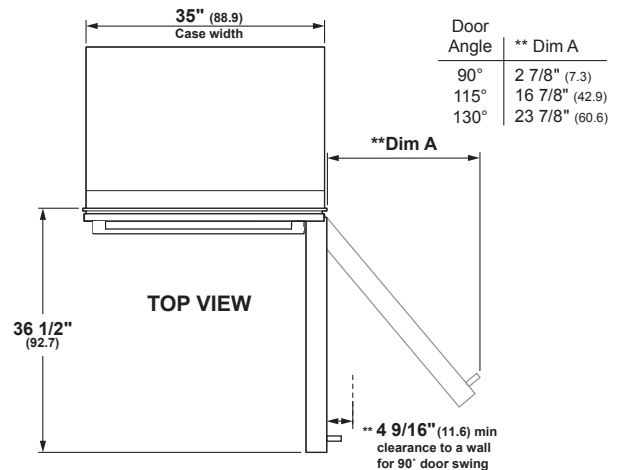

GROUNDING THE REFRIGERATOR

IMPORTANT—PLEASE READ CAREFULLY

FOR PERSONAL SAFETY, THIS APPLIANCE MUST BE PROPERLY GROUNDING.

The power supply cord of this appliance is equipped with a three-prong (grounding) plug which mates with a standard three-prong (grounding) wall receptacle to minimize the possibility of electric shock hazard from this appliance.

Have the wall outlet and circuit checked by a qualified electrician to make sure the outlet is properly grounded.

Where a standard 2-prong wall outlet is encountered, it is your personal responsibility and obligation to have it replaced with a properly grounded 3-prong wall outlet.

DO NOT UNDER ANY CIRCUMSTANCES, CUT OR REMOVE THE THIRD (GROUND) PRONG FROM THE POWER CORD.

DO NOT USE AN ADAPTER PLUG TO CONNECT THE REFRIGERATOR TO A 2-PRONG OUTLET.

DO NOT USE AN EXTENSION CORD WITH THIS APPLIANCE.

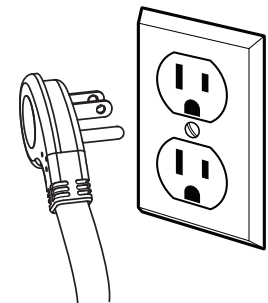

Café™ 21.3 Cu. Ft. Smart Built-In Bottom-Freezer Refrigerator

CDB36RP2RS1

CAFÉ

DISTINCT BY DESIGN™

DIMENSIONS AND INSTALLATION

SIDE PANELS

Side panels (not supplied) must be used whenever the sides of the refrigerator will be exposed. The 1/4" side panels will slip into the side case trim. Order side panels from your cabinet manufacturer.
*Depending on installation height.

FLOORING

For proper installation, this refrigerator must be placed on a level surface of hard material that is at the same height as the rest of the flooring. This surface should be strong enough to support a fully loaded refrigerator, or approximately 1500 lbs.

NOTE: Protect the finish of the flooring. Cut a large section of the cardboard carton and place under the refrigerator where you are working.

WATER AND ELECTRICAL LOCATIONS

The opening must be prepared with the electrical and water supply located as shown.

THE CUTOUT DEPTH MUST BE 24"

The refrigerator will project forward, slightly beyond adjacent cabinets, depending on your installation.

ADDITIONAL SPECIFICATIONS

A 120 volt, 60Hz, 15 or 20 amp power supply is required. An individual properly grounded branch circuit or circuit breaker is recommended.

Install a properly grounded 3-prong electrical receptacle recessed into the back wall. Electrical must be located on rear wall as shown.

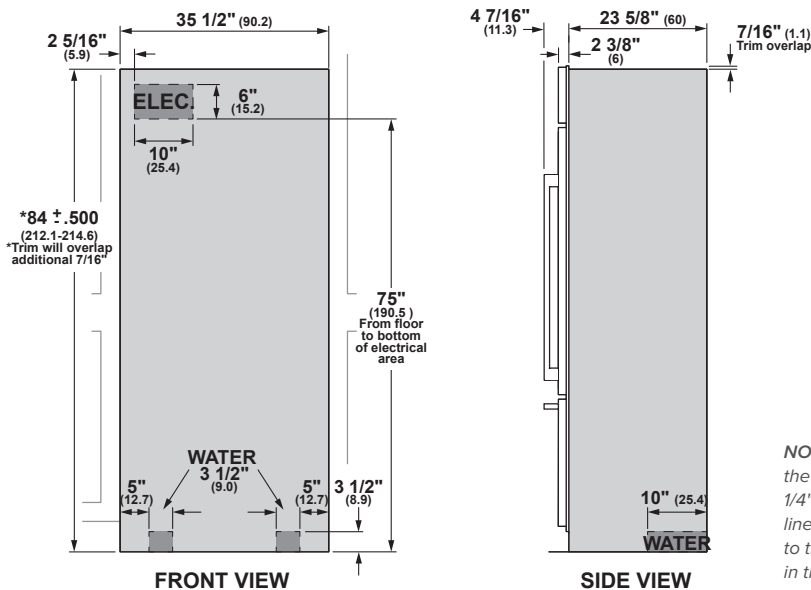
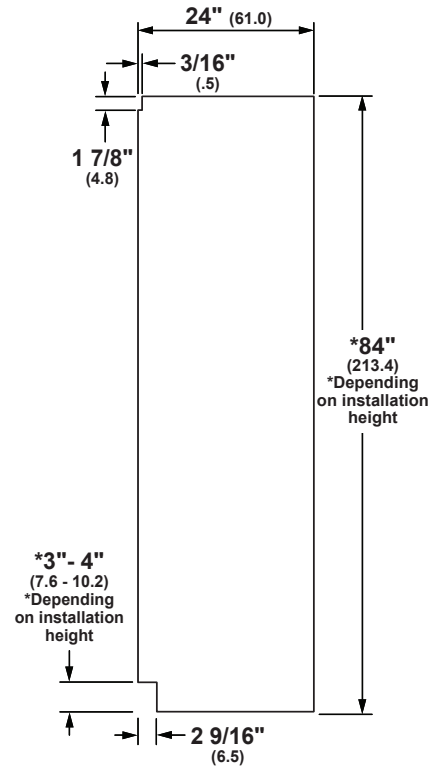

NOTE: GFI (ground fault interrupter) is not recommended. Water line can enter the opening through the floor or rear wall. The water line installed should be 1/4" O.D. copper tubing or GE SmartConnect™ tubing between the cold water line and water connection location. The line should be long enough to extend to the front of the refrigerator. Installation of an easily accessible shutoff valve in the water line is required.

Café™ 21.3 Cu. Ft. Smart Built-In Bottom-Freezer Refrigerator

CDB36RP2RS1

CAFÉ

DISTINCT BY DESIGN™

OVERALL DIMENSIONS

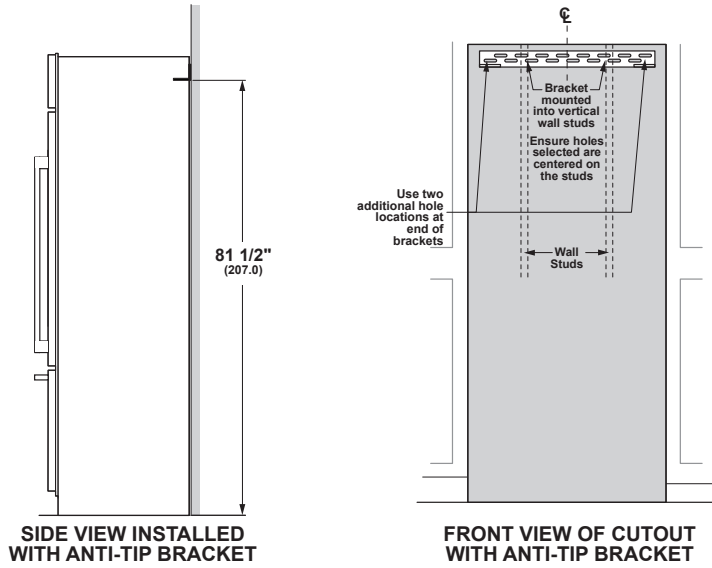

CUSTOM SIDE PANELS

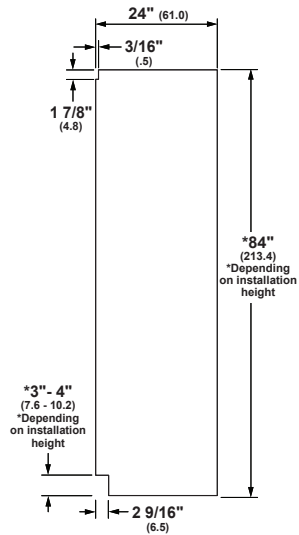

ADDITIONAL ACCESSORIES



CXSB2H2PPBZ
Brushed Bronze
Optional Kits



CXSB2H2PPBT
Brushed Black
Optional Kits



CXSB2H2PPCU
Brushed Copper
Optional Kits