

SPECIFICATION SHEET

PRODUCT FAMILY: **Sinks** FINISH: **Stainless Steel** SERIES: **PEAK** MODEL: **PKX11016**

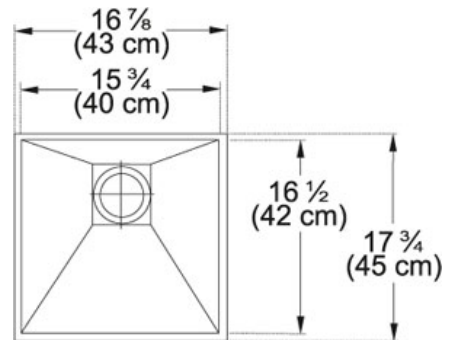

Product Information

FUN#	122.0074.944
US Part Number	PKX11016
Franke Integral Ledge	built-in
Minimum Cabinet Size	21"
Drain Opening	3 1/2"
Outer Dimensions	16 7/8"x17 3/4"
Bowl Size	15 3/4"x16 1/2"x9 7/8"
Number of Bowls	1
Type of Material	Stainless Steel

Accessories



112.0039.150



112.0066.060



112.0079.835



112.0173.260



112.0173.264

Suggested Products



115.0251.992



119.0066.616



119.0197.313



120.0296.741



133.0171.120



134.0297.202