

36"/30" TELESCOPING DOWNDRAFT VENTILATION

JXD7036YS – 36" x 42¹/₈" x 12¹/₈"

JXD7030YS – 30" x 42¹/₈" x 12¹/₈"

PRODUCT DIMENSIONS

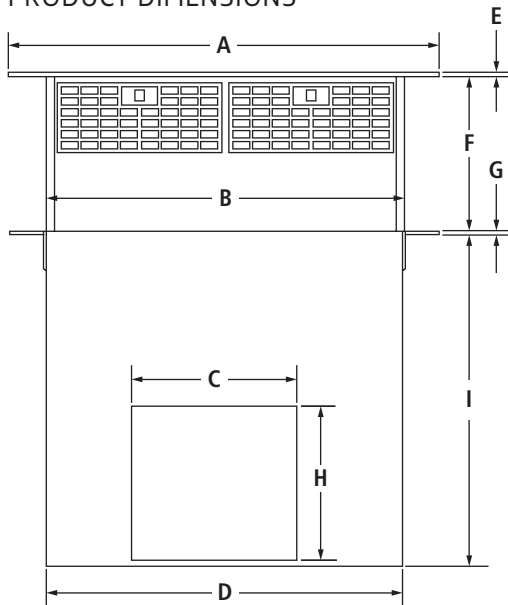

FRONT VIEW

MODEL #	JXD7036YS		JXD7030YS		
	in	cm	in	cm	
A	Overall width	36	91.4	30	76.2
B	Width of retractable vent	33	83.3	27	68.6
C	Width of blower motor box	16 ¹ / ₂	42.0	16 ¹ / ₂	42.0
D	Width of vent box	33 ¹ / ₄	84.5	27 ¹ / ₄	69.2
E	Height of top trim	1/2	1.3	1/2	1.3
F	Height of retractable vent	13	33.0	13	33.0
G	Height of end cap	1/8	0.3	1/8	0.3
H	Height of blower motor box	13 ¹ / ₈	33.4	13 ¹ / ₈	33.4
I	Height of vent box	28 ¹ / ₂	72.4	28 ¹ / ₂	72.4
J	Depth of top trim	2	5.1	2	5.1
K	Depth of retractable vent	1 ¹ / ₂	3.8	1 ¹ / ₂	3.8
L	Depth of vent box	2 ¹ / ₈	5.4	2 ¹ / ₈	5.4
M	Depth of blower motor box	10	25.4	10	25.4
N	Overall depth	12 ¹ / ₈	30.8	12 ¹ / ₈	30.8
O	Depth of reverse blower	4 ³ / ₄	12.1	4 ³ / ₄	12.1

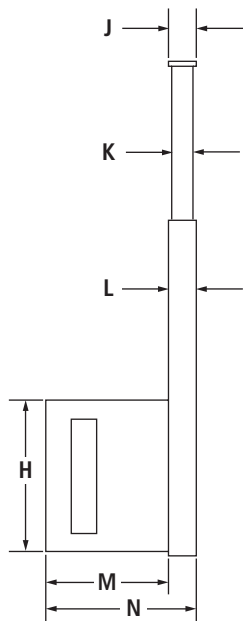

SIDE VIEW

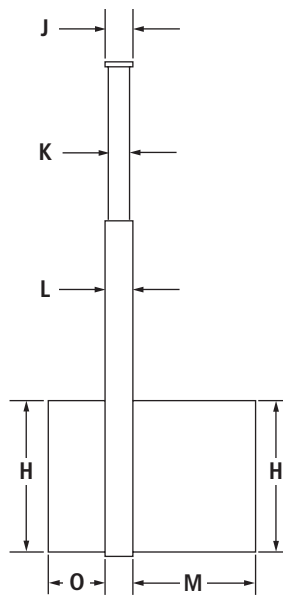

REVERSE BLOWER INSTALLATION –
SIDE VIEW

36"/30" TELESCOPING DOWNDRAFT VENTILATION

JXD7036YS – 36" x 42¹/₈" x 12¹/₈"

JXD7030YS – 30" x 42¹/₈" x 12¹/₈"

OPENING/CLEARANCE DIMENSIONS

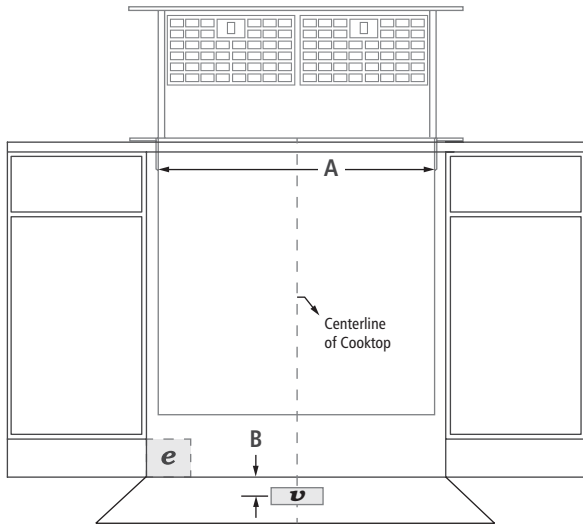

LOCATION REQUIREMENTS

Bull-nosed front edge countertops are not recommended. Some cooktop and vent combinations may require a countertop deeper than 25" (63.5 cm).

ELECTRICAL REQUIREMENTS

120 volt, 60 Hz, AC only, 15-amp fused, electrical circuit is required.

VENTING REQUIREMENTS

The vent is factory set for a 3¹/₄" x 10" (8.3 cm x 25.4 cm) rectangular or a 6" (15.2 cm) diameter vent system venting through the wall or floor. Do not terminate the vent in an attic or other enclosed area.

FRONT VIEW

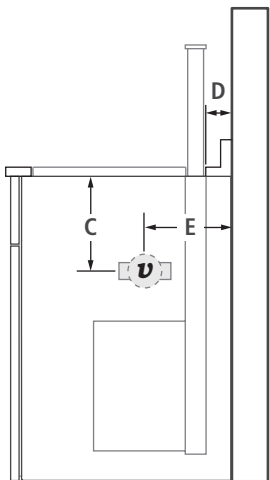

SIDE VIEW

MODEL #	JXD7036YS		JXD7030YS	
	in	cm	in	cm
A Width of cutout	33 ¹ / ₂	85.9	27 ¹ / ₂	69.9
B Depth from center of vent cutout to back wall – floor vent option	10	25.4	10	25.4
C Height from center of vent cutout to countertop – side wall vent option	21 ³ / ₈	54.1	21 ³ / ₈	54.1
D Depth from back wall to vent box cutout (min.)	1/2	1.3	1/2	1.3
E Depth from center of vent cutout to back wall – side wall vent option	10	25.4	10	25.4
F Recessed cooktop to countertop cutout	H + 17/8	H + 4.6	H + 17/8	H + 4.6
G Countertop cutout to backsplash (min.)	1/2	1.3	1/2	1.3
H* Rear overhang of cooktop	—	—	—	—
I Top trim to backsplash (min.)	1/4	0.6	1/4	0.6
J Vent box to back of cabinet (min.)	1/2	1.3	1/2	1.3
K Depth of backsplash (max.)	3/4	1.9	3/4	1.9
e Recommended junction box location				
v Recommended venting location	3 ¹ / ₄ " x 10" (8.3 cm x 25.4 cm) rectangular or 6" (15.2 cm) diameter cutout			

*Cooktop overhang will vary depending on model.

CUTOUT DIMENSIONS

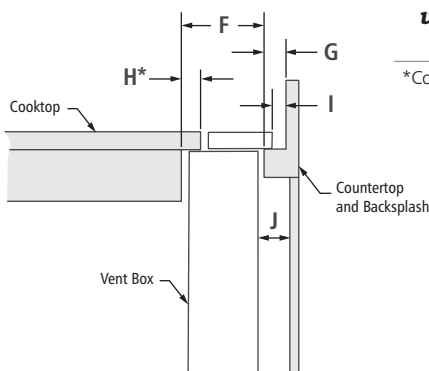

SIDE VIEW

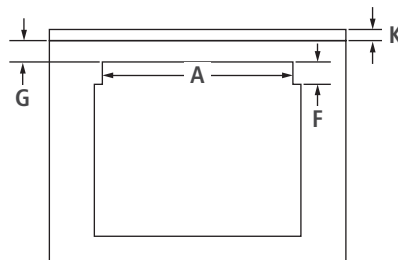

TOP VIEW – CUTOUT



JENN-AIR® DETAILED PLANNING DIMENSIONS

VENTILATION SELECTION CHART – COOKTOPS

MODEL #	PRO-STYLE™ HOODS			EURO-STYLE ISLAND-MOUNT HOODS		EURO-STYLE WALL-MOUNT HOODS		GLASS COLLECTION ISLAND-MOUNT HOOD	GLASS COLLECTION WALL-MOUNT HOODS		PERIMETRIC HOOD	OILED BRONZE WALL-MOUNT HOODS		EURO-STYLE TELESCOPING DOWNDRAFT SYSTEMS		CUSTOM HOOD LINERS	OVER-THE-RANGE MICROWAVE OVENS
	JXW9048WP	JXW9036WP JXU9136WP	JXW9030WP JXU9130WP	JXI8042WS	JXI8036WS	JXW8036WS JXW8836WS	JXW8030WS	JXI5036WS	JXW5036WS	JXW5030WS	JXP5032WS	JXW6036WR	JXW6030WR	JXD7036YS	JXD7030YS	UXL6048YSSA UXL6036YSSA	JMV9186W JMV8208W
INDUCTION COOKTOPS																	
36-INCH																	
JIC4536X – 5 Elements	■	■	—	★	★	★	—	★	★	—	★	■	—	★	—	★	■
30-INCH																	
JIC4430X – 4 Elements	■	■	■	■	★	★	★	★	★	★	★	■	■	★	★	★	■
CONVENTIONAL GAS COOKTOPS																	
36-INCH (less than 60,000 BTU total)																	
JGC9536BD – 5 Burners	■	■	—	★	★	★	—	★	★	—	★	★	—	★	—	★	■
JGC1536AD – 5 Burners	■	■	—	★	★	★	—	★	★	—	★	■	—	★	—	★	■
JGC8536BD – 5 Burners	■	■	—	★	★	★	—	★	★	—	★	■	—	★	—	★	■
30-INCH (less than 60,000 BTU total)																	
JGC9430BD – 4 Burners	■	■	■	■	★	★	★	★	★	★	★	★	★	★	★	★	■
JGC1430AD – 4 Burners	■	■	■	■	★	★	★	★	★	★	★	■	■	★	★	★	■
JGC8430CD – 4 Burners	■	■	■	■	★	★	★	★	★	★	★	■	■	★	★	★	■
CONVENTIONAL ELECTRIC COOKTOPS																	
36-INCH																	
JEC4536Y – 5 Elements	■	■	—	★	★	★	—	★	★	—	★	■	—	★	—	★	■
JEC9536BD – 5 Elements	■	■	—	★	★	★	—	★	★	—	★	★	—	★	—	★	■
JEC8536BD – 5 Elements	■	■	—	★	★	★	—	★	★	—	★	■	—	★	—	★	■
30-INCH																	
JEC4530Y – 5 Elements	■	■	■	■	★	★	★	★	★	★	★	■	■	★	★	★	■
JEC9530BD – 5 Elements	■	■	■	■	★	★	★	★	★	★	★	★	★	★	★	★	■
JEC8430BD – 4 Elements	■	■	■	■	★	★	★	★	★	★	★	■	■	★	★	★	■

A. Custom hood liners can be used with any of the following blower motors: UXB1200DYS, UXB0600DYS, UXI1200DYS or UXI0600DYS.

KEY	
★	Style and Performance Pair
■	Performance Pair
—	Not Recommended

Product dimension, cutout and installation specifications are provided for planning purposes only. Before installing any product, be sure to verify cutout dimensions and electrical/gas connections as actual product dimensions may vary.



JENN-AIR® DETAILED PLANNING DIMENSIONS

VENTILATION SELECTION CHART – RANGETOPS AND RANGES

MODEL #	PRO-STYLE™ HOODS			EURO-STYLE ISLAND-MOUNT HOODS		EURO-STYLE WALL-MOUNT HOODS		GLASS COLLECTION ISLAND-MOUNT HOOD	GLASS COLLECTION WALL-MOUNT HOODS		PERIMETRIC HOOD	OILED BRONZE WALL-MOUNT HOODS		EURO-STYLE TELESCOPING DOWNDRAFT SYSTEMS	CUSTOM HOOD LINERS		OVER-THE-RANGE MICROWAVE OVENS	
	JXW9048WP	JXW9036WP JXU9136WP	JXW9030WP JXU9130WP	JXI8042WS	JXI8036WS	JXW8036WS JXW8836WS	JXW8030WS	JXI5036WS	JXW5036WS	JXW5030WS	JXP5032WS	JXW6036WR	JXW6030WR	JXD7036YS JXD7030YS	1200 or 600 CFMA	600 CFMB	JMV9186W JMV8208W	
PRO-STYLE® RANGETOPS																		
48-INCH (more than 60,000 BTU total)																		
JGCP548WP – 6 Burners & Griddle	★	—	—	—	—	—	—	—	—	—	—	—	—	—	★	—	—	
36-INCH (less than 60,000 BTU total)																		
JGCP536WP – 4 Burners & Griddle	★	★	—	■	■	■	—	■	■	—	■	■	—	—	★	★	—	
36-INCH (more than 60,000 BTU total)																		
JGCP436WP – 6 Burners	★	★	—	—	—	—	—	—	—	—	—	—	—	—	★	—	—	
30-INCH (less than 60,000 BTU total)																		
JGCP430WP – 4 Burners	■	★	★	■	■	■	■	■	■	■	■	■	■	—	★	★	—	
48-INCH (less than 60,000 BTU total)																		
JGD8348CDP – 4 Burners & Grill Assembly	—	—	—	—	—	—	—	—	—	—	—	—	—	—	★	—	—	
PRO-STYLE® DUAL-FUEL AND GAS RANGES																		
48-INCH (more than 60,000 BTU total)																		
JDRP548WP – 6 Burners & Griddle	★	—	—	—	—	—	—	—	—	—	—	—	—	—	★	—	—	
JGRP548WP – 6 Burners & Griddle	★	—	—	—	—	—	—	—	—	—	—	—	—	—	★	—	—	
36-INCH (less than 60,000 BTU total)																		
JDRP536WP – 4 Burners & Griddle	★	★	—	■	■	■	—	■	■	—	■	■	—	—	★	★	—	
JGRP536WP – 4 Burners & Griddle	★	★	—	■	■	■	—	■	■	—	■	■	—	—	★	★	—	
36-INCH (more than 60,000 BTU total)																		
JDRP436WP – 6 Burners	★	★	—	—	—	—	—	—	—	—	—	—	—	—	★	—	—	
JGRP436WP – 6 Burners	★	★	—	—	—	—	—	—	—	—	—	—	—	—	★	—	—	
30-INCH (less than 60,000 BTU total)																		
JDRP430WP – 4 Burners	—	★	★	—	■	■	■	■	■	■	■	■	■	—	★	★	—	
JGRP430WP – 4 Burners	—	★	★	—	■	■	■	■	■	■	■	■	■	—	★	★	—	
SLIDE-IN RANGES																		
Dual-Fuel and Gas Conventional (less than 60,000 BTU total)																		
JDS886BDP – 4 Burners	■	★	★	■	★	★	★	★	★	★	★	★	■	■	—	★	★	■
JDS8850CD – 4 Burners	■	■	■	■	★	★	★	★	★	★	★	★	■	■	—	★	★	■
JGS8860BDP – 4 Burners	■	★	★	■	★	★	★	★	★	★	★	★	■	■	—	★	★	■
JGS8850CD – 4 Burners	■	■	■	■	★	★	★	★	★	★	★	★	★	★	—	★	★	■
ELECTRIC CONVENTIONAL																		
JES8850CA – 5 Elements	■	■	■	■	★	★	★	★	★	★	★	★	■	■	—	★	★	■

A. Custom hood liners can be used with any of the following blower motors: UXB1200DYS, UXB0600DYS, UXI1200DYS or UXI0600DYS.
 B. Blower motor UXB0600DYS is rated for up to 65,000 BTUs and can be used with the rangetops and ranges indicated.

KEY	
★	Style and Performance Pair
■	Performance Pair
—	Not Recommended

