

VW30B

FEATURES

Breathe cleaner air and enjoy less greasy residue in your kitchen

Coordinates with Wolf ovens and cooktops with its contemporary, low-profile, black glass look

Adjust as needed with recessed controls that provide a sleeker look, yet maintain ultimate blower control

Matches the same heavy-duty stainless-steel construction, hand-finished hemmed edges, and welded seams of all Sub-Zero, Wolf, and Cove products

Select from internal, in-line, or remote blower options

Lights your workspace with two LED light bars with two brightness settings

Reach ceiling heights with its telescoping chimney

Minimizes the backward flow of cold air with backdraft transition

ACCESSORIES

Backsplash

Flue Extension

Recirculating Kit

Remote Control

Inline Blowers

Internal Blowers

Remote Blowers

Accessories available through an authorized dealer. For local dealer information, visit subzero-wolf.com/locator.



BLOWER OPTIONS

- 300 CFM Internal
- 600 CFM Internal
- 600 CFM Inline
- 600 CFM Remote

PRODUCT SPECIFICATIONS

Model	VW30B
Dimensions	30"W x 2 1/4"H x 19 1/4"D
Weight	53 lbs
Electrical Supply	110/120 VAC, 60 Hz
Electrical Service	15 amp dedicated circuit
Discharge Location	Vertical
Discharge Dimensions	6" Round
Bottom of Hood to Countertop	24" to 36"
Receptacle	3-prong grounding-type

ELECTRICAL

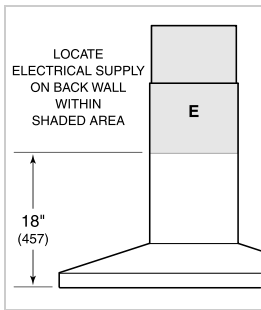

NOTE: Dimensions in parenthesis are in millimeters unless otherwise specified

DIMENSIONS

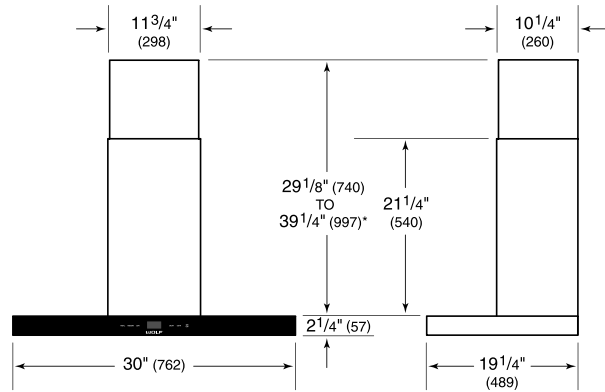

*49 1/8" (1248) to 59 1/4" (1505) with accessory flue extension.